



6.3.4
PROFESSIONAL
DEVELOPMENT
AND
TRAINING COURSES



**FACULTY OF EDUCATION
DAYALBAGH EDUCATIONAL INSTITUTE
(DEEMED TO BE UNIVERSITY)
DAYALBAGH, AGRA**



**Ministry of Education
Government of India**

A Two Day International Online Workshop

on

Integration of Animation in Teaching-Learning

28th and 29th January, 2021

organized by

Centre for Knowledge Acquisition, Retention and Transformation (C-KART)

School of Education

Pandit Madan Mohan Malaviya National Mission on Teachers and Teaching, MoE, Govt. of India

CERTIFICATE OF PARTICIPATION

It is certified that **MR. TANVEER AHMAD LONE** from **GDC, BARAMULLA, J & K** participated in the Two Day International Online Workshop on Integration of Animation in Teaching-Learning from 28th to 29th January, 2021.



Jyoti Kharbanda
Dr. Anjana Verma & Mrs. Jyotika Kharbanda
Conveners

Nandita Satsangee

Prof. Nandita Satsangee
SoE Coordinator

Archana Kapoor

Prof. Archana Kapoor
Dean, Faculty of Education



Teaching Learning Centre, Ramanujan College
University of Delhi

under the aegis of

MINISTRY OF EDUCATION

PANDIT MADAN MOHAN MALAVIYA NATIONAL MISSION ON TEACHERS AND TEACHING

This is to certify that

Dr. Naseer Ahmad Lone

of

Department of Computer Applications, Government Degree College

Baramulla (J & K)

successfully completed TWO-WEEK INTERDISCIPLINARY REFRESHER
COURSE/FACULTY DEVELOPMENT PROGRAMME for

“ADVANCED RESEARCH METHODOLOGY Tools and Techniques”

from 30 January, 2021 - 14 February, 2021 and obtained

Grade **A+**.



Blockchain Hash: 0x75d1b49332f102506aff40b314d335974b62518d797abd54a535e7ed1a4354bb

(Signature)

Dr. S. P. AGGARWAL
(Director, TLC)

Principal, Ramanujan College



(Signature)

Mr. Vipin Ra
(Programme Dir
Ramanujan Co



Nachiketa College of Computer Science
Commerce & Advanced Technology
VijayNagar, Jabalpur, (MP)



Permanent Affiliation - Rani Durgawati Vishwavidyalaya, Jabalpur

5 Day's FDP
(Faculty Development Program)

On

Possibilities of Research, Research
Methodology & Research Paper Writing

-:Organized by:-

IQAC and department of Arts

Date: - 2nd to 6th March 2021 || Time: - 1.00 pm to 2.00 pm

CERTIFICATE OF
PARTICIPATION

This is to certify

Zubair Ahmad thoker

Assistant Professor

Government Degree College Baramulla

Has successfully participated in the 5 Day's FDP Program on-
"Possibilities of Research, Research Methodology & Research Paper
Writing" organized by IQAC and department of Arts, Nachiketa College
of Computer Science Commerce & Advanced Technology VijayNagar,
Jabalpur, (M.P.)

Coordinator
Mr. Ajay Shukla
Nachiketa College
Jabalpur (M.P.)

Convener
Mrs. Suchlata Dubey
HOD, Arts
Nachiketa College
Jabalpur (M.P.)

IQAC Coordinator
Mr. R.K. Aloney
HOD, Science
Nachiketa College
Jabalpur (M.P.)

Patron
Dr. P.R. Chandra
Principal
Nachiketa College
Jabalpur (M.P.)

Certificate No. 443

S.No. : 299



UGC HUMAN RESOURCE DEVELOPMENT CENTRE UNIVERSITY OF JAMMU

UGC SPONSORED REFRESHER COURSE
(UNDER RUSA)

This is to certify that

(Name of Participant) Dr. Fayees Ahmad Dar Asst. Prof.
(Designation)
(College/University) C.D.S. Boys, Baromulla (Nags)
(Place)
Participated in the Refresher Course in Mathematical Sciences
from 04-01-2021 to 17-01-2021 and obtained grade 'A'

DIRECTOR

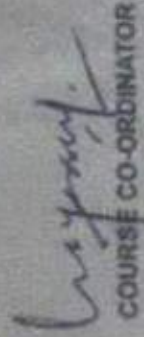
COURSE CO-ORDINATOR

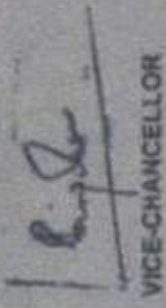
VICE-CHANCELLOR

Dated of issue: September 12, 2020

Certificate No: 4407942



Higher Education Department

Government of Union Territory of Jammu and Kashmir

In collaboration with

Grassroots Innovation and Augmentation Network

GIAN, India



One-Week National e-Workshop on "Leveraging Education for Harnessing Entrepreneurship, Research & Innovation" LEHERI-2020

Participation Certificate

This is to certify that Prof./ Dr. / Mr. /Ms. Ab. Rashid Malik
affiliated with College/ University/ Others Govt. Degree College Baramulla
has participated in One Week National e-Workshop on "Leveraging Education for Harnessing Entrepreneurship, Research & Innovation", organized by Higher Education Department (H. E. D), Govt. of Jammu and Kashmir (UT) in collaboration with Grassroots Innovation and Augmentation Network (GIAN, India) held from September 07 to 12, 2020.

Dr. Sofi Mohammad Zuber
Member, Coordination
Cell, H. E. D.

Dr. Anamika Day
C.E.O,
GIAN

Mr. Sarjoo Rana (KAS)
Deputy Secretary, H.E.D,
Govt. of J&K (UT)

Prof. Anil K. Gupta
CSIR Bhatnagar Fellow
Founder, HBN,
SRISTI, GIAN & NIF

Organized by Coordination Cell, Higher Education Department, Govt. of Jammu & Kashmir, (UT) India



Government of India
Ministry of Human Resource
Development

*Teaching Learning Centre
Ramanujan College
University of Delhi*

Sponsored by

MINISTRY OF HUMAN RESOURCE DEVELOPMENT
PANDIT MADAN MOHAN MALAVIYA
NATIONAL MISSION ON TEACHERS AND TEACHING

Certificate

This is to certify that

Mr. Ajmair Singh Sodhi

of

Govt. Degree College, Baramulla, J&K

has successfully completed One Week Faculty Development Programme on
"Open Source Tools for Research" from June 08 - June 14, 2020.



Dr. S.P. AGGARWAL
(Principal)

Mr. Sahil Puthak
(Convenor)



Ref no: EICT/.04/2020-21/FDP/OL/31

Electronics & ICT Academy
Supported by Ministry of Electronics and Information Technology (MeitY), Govt. of India
Indian Institute of Technology Guwahati

Certificate of Participation

This is to certify that

Mr. Ajmair Singh Sodhi

Govt. Degree College, Baramulla, Jammu and Kashmir

has participated in the One-Week Online Faculty Development Programme on "Mentoring Pedagogy and Teaching for Higher Education" organized by E&ICT Academy IIT Guwahati held from 29 June to 06 July, 2020 in association with the Departments of Electrical Engineering and Mechanical Engineering of Dr. B. C. Roy Engineering College, Durgapur.

Prof. Ratnajit Bhattacharjee
PI, E&ICT Academy
Indian Institute of Technology
Guwahati

Mr. Anjan Chowdhury
Managing Director, Indian Skill Academy
Empanelled Member, E&ICT Academy
IIT Guwahati

Dr. Pijush Pal Roy
Director
Dr. B. C. Roy Engineering College
Durgapur

NAAC Accredited Grade "A+"
Hazratbal, Srinagar

UGC -SPONSORED REFRESHER COURSE
IN
GENDER STUDIES (INTERDISCIPLINARY)

This is to certify that Dr. Naushad Ahmad Wani, Assistant Professor
Department of Psychology, Govt. Degree College (Boys), Baramulla affiliated
Kashmir University participated in the Refresher Course from January 13, 2020

January 25, 2020 and obtained Grade (A+).

Prof. Nilofer Khan
Course Coordinator

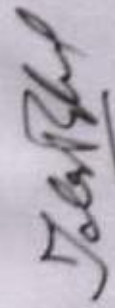
Prof. Talat Ahmad
Vice-Chancellor



UGC HUMAN RESOURCE DEVELOPMENT CENTRE UNIVERSITY OF JAMMU

UGC SPONSORED REFRESHER COURSE
(UNDER RUSA)

This is to certify that

Name of Participant) Ms. Nuzhat Rehman Asst. Prof. in Chemistry
 (Designation)
 College/University) Govt. Degree College, Baramulla (Place)
 Participated in the Refresher Course in (C) Disaster Management
 from 03-01-2020 to 17-01-2020 and obtained grade 'A'

RECTOR

COURSE CO-ORDINATOR

VICE-CHANCELLOR

Workshop on "NAAC TALK" under CPE/UGC TEP

GOVERNMENT DEGREE COLLEGE BARAMULLA

(NAAC Re-Accredited Grade 'A'
College with Potential for Excellence)

Telefax : 01952-234214

e-mail: varmulcollege@gmail.com

website: www.baramullacollege.net

No. GCB/UGC/ 4798-4857

Dated: 4/3/2020



Certificate of Participation

This is to certify that Prof./Dr./Mr./Ms. Nuzhat Rehman
GDC (Boys) Baramulla

participated in CPE/UGC sponsored One Day Workshop on "NAAC TALK"
conducted as part of Teacher Enrichment Programme (TEP) of CPE/UGC
Scheme organized by *Internal Quality Assurance Cell (IQAC)* of
Government Degree College Baramulla held on 4th of March, 2020.

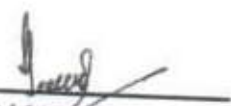
COORDINATOR IQAC
Govt. College Baramulla
Coordinator IQAC
Convener UGC/CPE Scheme
Associate Professor Botany



Principal
Govt. College Baramulla
Prof. F. R. Beigh
Principal
Govt. Degree College Baramulla



Ministry of Finance
Government of India

Central Board of Direct Taxes

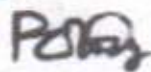
This is to certify that Mr/Ms **NUZHAT REHMAN** (PAN: **ATFPR9927B**) has paid taxes for the Assessment Year **2019-20** and filed the Income Tax return. We appreciate the taxpayer, in the 'Bronze' category in recognition, of the contribution towards building this great Nation.



P C Mody
Chairman



2019413516354



CERTIFICATE
OF APPRECIATION



GOVERNMENT DEGREE COLLEGE ANANTNAG



College with Potential for Excellence (CPE) status by UGC
NAAC Accredited Grade "A" (CGPA: 3.03)

Website: <http://www.gdcboysang.ac.in>

Tel. No.: (0) 01932-222308

Fax: 01932-223509

E-Mail: principal@gdcboysang.ac.in

Certificate of Participation

This certificate is presented to

NUZHAT REHMAN

of

GOVERNMENT DEGREE COLLEGE BARAMULLA

for participating in the Webinar on the theme "Strong Immunity and Positive Mental Health - Two sides of the Same Coin" delivered by Dr. Abdul Majid, Associate Professor, Psychiatry SKIMS organised by Department of Biotechnology, Government Degree College Anantnag on 19th August, 2020.

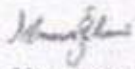

Dr. Minerva Ghani
Organising Secretary



Dr. Mohd Ashraf Khan
Organising Secretary



Mrs. Sameena Ismail
Convener

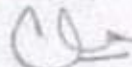

Prof. Mushtaq Ali Mir
Patron



Government Degree College for Women Anantnag

(Affiliated to University of Kashmir, NAAC Re-Accredited Grade "B (CGPA2.81)")



DMTQIS-CE000197

Certificate of Participation

Presented to Nuzhat Rehman *for participating in, Webinar*
on "Impact of Covid-19 on Higher Education and Role of Teacher"
organized by Department of Education, Government Degree College
for women Anantnag on 25-08-2020.

Ms. Parveena Akhter

Head, Department of Education
GDC women Anantnag

Date: 25/08/2020

Dr. Ali Mohammad Dar

Principal,
GDC women Anantnag

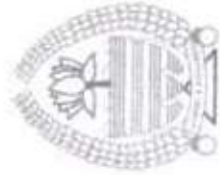

OFFICE OF THE

DEPUTY COMMISSIONER BARAMULLA
COMMENTATION CERTIFICATE



I, Dr. G. N. Itoo, Deputy Commissioner Baramulla confer this
commendation certificate in favour of

*Mtr. Nuzhat Rehman, Assistant Professor (HOD) Department of
Chemistry, Govt. Degree College Baramulla*

*in recognition of her contribution for supporting District Administration
Baramulla in preparation of Hand Sanitizers, as per WHO Standards, during*

COVID-19 Pandemic Mitigation efforts.

I wish her all the best for her future endeavors.

No.: DCB/4807

Date: 12-09-2020

Dr. G. N. Itoo

Deputy Commissioner Baramulla.



AMAR SINGH COLLEGE

A Constituent College of Cluster University Srinagar

Chaji Bagh, Srinagar, J&K, 190008

NAAC Accredited



CERTIFICATE OF PARTICIPATION

This certificate is awarded to

NUZHAT REHMAN

of

GOVT DEGREE COLLEGE, BARAMULLA

in recognition of active participation in the International Webinar on "Leveraging Artificial Intelligence in Healthcare- Special Reference to COVID-19 Pandemic" held on 28th July, 2020.

Certificate No: ASC/FM2Q1-CE002167

			
(Dr. Syed Muzahar Asghar) (Prof. Syed Idrisul Munawwar) (CO-ORDINATOR) Assistant Professor Computer Science	(Dr. Anand Nayyar) (RESOURCE PERSON) Researcher & Scientist Duy Tan University, Vietnam	(Prof. Bashir Ahmad Rathore) (PROGRAMME DIRECTOR) Principal Amar Singh College, Srinagar	(Prof. (Dr.) Yasoon Ahmad Shah) (PATRON) Director Colleges, J&K, Higher Education Dept.

**NATIONAL INSTITUTE OF TECHNOLOGY,
SRINAGAR (J&K) 190006**
Department of Chemistry

TEQIP-3



E Certificate No. CHEM/CAPM/556

CERTIFICATE

This is to certify that **Nuzhat Rehman**
of *Kashmir University, Srinagar (JK)*
has attended TEQIP-III sponsored one week online Short Term Course

On

"Chemistry of Advanced Functional Materials (CAPM-2020)"
Organized by Department of Chemistry, National Institute of Technology,
Srinagar during 21-25 September, 2020.

Dr. Mohd. Aslam
Coordinator CAPM 2020

Dr. J. A. Bandy
(Head, Department of Chemistry)



Government Degree College for Women Anantnag

(Affiliated to University of Kashmir, NAAC Re-Accredited Grade "B" (CGPA 2.3117)



DMTQIS-CE000197

Certificate of Participation

*Presented to Nuzhat Rehman for participating in, Webinar
on "Impact of Covid-19 on Higher Education and Role of Teacher"
organized by Department of Education, Government Degree College
for women Anantnag on 25-08-2020.*

Ms. Parveen Akhter

Head, Department of Education
GDC women Anantnag

Date: 25-08/2020

Dr. Ali Mohammad Dar

Principal,
GDC women Anantnag



GOVERNMENT DEGREE COLLEGE BARAMULLA

1944C Accredited (Grade A)
College with Potential for Transformation Status (CPS)

No. GCB/ST/D/1133



NATIONAL WEBINAR



6TH INTERNATIONAL YOGA DAY - 2020

CERTIFICATE OF PARTICIPATION

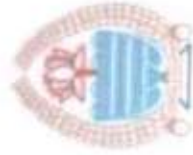

This is to certify that Nuzhat Rehman attended one day National Webinar on the occasion of celebration 6th international YOGA day on 21-06-2020, organized by Department of Physical Education and Sports in collaboration with NCC & NSS units of the College.

Prof. Muhammad Masood Rather
Principal

Dr. Tameer Akmal Bhat
Organizing Secretary

Prof. Rahmat Shah
Organizing Member



GOVERNMENT DEGREE COLLEGE ANANTNAG



College with Potential for Excellence (CPE) status by UGC
NAAC Accredited Grade "A" (CGPA: 3.03)

Website: <http://www.gdc.anantnag.edu>

Tel. No.: (019) 8939-80008

Fax: 8939-80009

E-Mail: princ@anag.gdc.anantnag.edu.in

Certificate of Participation

This certificate is presented to

NUZHAT REHMAN

of

GOVERNMENT DEGREE COLLEGE BARAMULLA

for participating in the Webinar on the theme "**Strong Immunity and Positive Mental Health - Two sides of the Same Coin**" delivered by **Dr. Abdul Majid, Associate Professor, Psychiatry SKIMS** organised by Department of Biotechnology, Government Degree College Anantnag on 19th August, 2020.

Dr. Muneera Ghazi
Organising Secretary

Dr. Shahid Ashraf Khan
Organising Secretary

Mrs. Saimona Inam
Chairperson

Prof. Mubshiq Ali Mir
Patron



AMAR SINGH COLLEGE

A Constituent College of Cluster University Srinagar

Chag Bagh, Jammu - J.K. 190008

MAAC Accredited



CERTIFICATE OF PARTICIPATION

This certificate is awarded to

NUZHAT REHMAN

of

GOVT DEGREE COLLEGE, BARAMULLA

in recognition of active participation in the International Webinar on "Leveraging Artificial Intelligence in Healthcare- Special Reference to COVID-19 Pandemic" held on 28th July, 2020.

CERTIFICATE No: ASC/FM/2021-CE002167

			
(Dr. Nuzhat Rehman) Principal Govt Degree College, Baramulla	(Dr. Anand Nayyar) Principal Govt Degree College, Baramulla	(Prof. Badar Ahmad Rather) Principal Govt Degree College, Baramulla	(Dr. J.K. Yousaf) Principal Govt Degree College, Baramulla



GOVERNMENT DEGREE COLLEGE ANANTNAG



College with Potential for Excellence (CPE) status by UGC
NAAC Accredited Grade "A" (CGPA: 3.93)

Website: <http://www.gdcaanantnag.in> Tel. No.: 019-8493-12345 Fax: 019-8493-12345 E-Mail: pricedes@gdcaanantnag.in

Certificate of Participation

This certificate is presented to

MUZHAT NEHMAN

of

GOVERNMENT DEGREE COLLEGE BARAMULLA

for participating in the Webinar on the theme "Strong Immunity and Positive Mental Health - Two sides of the Same Coin" delivered by Dr. Abdul Majid, Associate Professor, Psychiatry SKIMS organised by Department of Biotechnology, Government Degree College Anantnag on 19th August, 2020.

Dr. Muberra Ghani
Organising Secretary

Dr. Mohd Adilul Islam
Organising Secretary

Mrs. Nuzume Jussali
Convener

Prof. Mubshir AB Mir
Patron



Government Degree College for Women Anantnag

Affiliated to University of Kashmir, N.A.C. No. Accredited Grade "B" (CGPA 2.81) '73



DMT01S-CE000197

Certificate of Participation

Presented to Nuzhat Rehman *for participating in, Webinar*
on "Impact of Covid-19 on Higher Education and Role of Teacher"
organized by Department of Education, Government Degree College
for women Anantnag on 25-08-2020.

M. Parveen Akhter

Ms. Parveen Akhter
Head, Department of Education
GDC Women Anantnag

Date: 25-08-2020

Dr. Ali Mohammad Dar

Dr. Ali Mohammad Dar
Principal,
GDC Women Anantnag



GOVERNMENT DEGREE COLLEGE BARAMULLA

1954

No. GCN/ST/01/1/23



NATIONAL WEBINAR



6TH INTERNATIONAL YOGA DAY - 2020

CERTIFICATE OF PARTICIPATION



This is to certify that Muzhat Rehman attended one day National Webinar on the occasion of celebration 6th international YOGA day on 21-06-2020, organized by Department of Physical Education and Sports in collaboration with NCC & NSS units of the College.

Prof. Mubammad Mubhammad Azzam
Principal

Dr. Tameer Ahmad Khan
Organizing Secretary

Prof. Rehman Ullah
Organizing Member



UNIVERSITY GRANTS COMMISSION



HUMAN RESOURCE DEVELOPMENT CENTRE

University of Mysore

UGC Sponsored Faculty Induction Programme (Online)

Certificate of Participation

This is to Certify that

Dr. Muzamil Ahmad Bhat, Asst Professor of Physics,

Govt. Degree College (Boys), Baramulla,

affiliated to University of Kashmir

Participated in the First Faculty Induction Programme.

From 23.10.2020 To 19.11.2020 and obtained B Grade

Mudatala Namani
Director

L. Nayth
Co-ordinator

S. Hemant
Prof. G. Hemantha Kumar
Vice-Chancellor

SRI PRATAP COLLEGE, SRINAGAR

ONE DAY SEMINAR ON

"LEARNING OUTCOMES BASED CURRICULUM FRAMEWORK (LOCF)"

VIS-À-VIS BIOTECHNOLOGY

11th MARCH, 2020

Funded by :- Department of Higher Education, Govt. of Jammu & Kashmir

Certificate Of Participation

This is to certify that PROF. UBAID SHARIEF MUKHDOOMI Department of Biotechnology
from GDC (Boys), Baramulla participated in Seminar on Learning Outcomes Based Curriculum
Framework vis-à-vis Biotechnology. The program was organized by Department of
Biotechnology & Bioinformatics.



Seminar Coordinators
(Dr. Roohi Mushtaq & Dr. Sadiq Majeed)



Seminar Director
Prof. (Dr.) Khursheed A. Khan

Workshop on "NAAC TALK" under CPE/UGC TEP

GOVERNMENT DEGREE COLLEGE BARAMULLA

(NAAC Re-Accredited Grade 'A'
College with Potential for Excellence)
Telefax : 01952-234214
e-mail: yarmulcollege@gmail.com
website: www.baramullacollege.net

No. GCB/UGC/ 4798-487
Dated: 04-03-2020



Certificate of Participation

This is to certify that Prof./Dr./Mr./Ms. Ubaid Shareif
Makhdoomi (GDC (Boys) Baramulla

participated in CPE/UGC sponsored One Day Workshop on "NAAC TALK"
conducted as part of Teacher Enrichment Programme (TEP) of CPE/UGC
Scheme organized by *Internal Quality Assurance Cell (IQAC)* of
Government Degree College Baramulla held on 4th of March, 2020.

Abdul Majid Chalkoo
Coordinator IQAC
Convener UGC/CPE Scheme
Associate Professor Botany

Prof. F. R. Beigh
Principal
Govt. Degree College Baramulla



Teaching Learning Centre, Ramanujan College
University of Delhi

under the aegis of

MINISTRY OF HUMAN RESOURCE DEVELOPMENT

PANDIT MADAN MOHAN MALAVIYA NATIONAL MISSION ON TEACHERS AND TEACHING

This is to certify that

Ubaid Sharif Makhdoomi

of

Department of Biotechnology, Govt. Degree College Barabanki

successfully completed a 4-Week Induction/Orientation Programme
"Faculty in Universities/Colleges/Institutes of Higher Education"
from June 26 - July 24, 2020 and obtained
grade **A+**



010cckhain_bksh...0x84b50376c4793de8d253ce3cf979993c9188ec580a17a45c71d8da8fbd034f58

A handwritten signature in blue ink.

Dr. S.P. AGGARWAL

Director, TLC

Principal, Ramanujan College

Dated of issue: September 12, 2020



Higher Education Department

Government of Union Territory of Jammu and Kashmir

Order No. /Ho. 4407931



Grassroots Innovation and Augmentation Network

GIAN, India

"Leveraging Education for Harnessing Entrepreneurship, Research & Innovation" LEHERI-2020

Participation Certificate

This is to certify that Prof./ Dr. / Mr. /Ms. Dr Sheeraz Ahmad Tantray affiliated with College/ University/ Others Govt Degree College Baramulla has participated in One Week National e-Workshop on "Leveraging Education for Harnessing Entrepreneurship, Research & Innovation", organized by Higher Education Department (H. E. D), Govt. of Jammu and Kashmir (UT) in collaboration with Grassroots Innovation and Augmentation Network (GIAN, India) held from September 07 to 13, 2020.

[Signature]

Dr. S. J. M. Harshad
Member, Coordination
Cell, H. E. D.

[Signature]

Dr. Anandika Day
C.E.O.
GIAN

[Signature]

Mr. Anil V Rana (IAS)
Deputy Secretary, H.E.D,
Govt. of J&K (UT)

[Signature]

Dr. Arun K. Gupta
CSIR Bhatnagar Fellow
Founder, HBN,
SRISTI, GIAN & NIF

Organized by Coordination Cell, Higher Education Department, Govt. of Jammu & Kashmir, (UT) India



Teaching Learning Centre, Ramanujan College
University of Delhi

under the aegis of
INSTITUTE OF HUMAN RESOURCE DEVELOPMENT

PANDIT MADAN MOHAN MALAVIYA NATIONAL MISSION ON TEACHERS AND TEACHING

This is to certify that

Mr. Ishtiyaq Ahmad Sheikh

of

Dept of Biotechnology, GDC Boys Baramulla (J&K)

successfully completed a 4-Week Induction/Orientation Programme
"Faculty in Universities/Colleges/Institutes of Higher Education
from June 26 - July 24, 2020 and obtained
grade **A+**



Eloqckchain Hash: 0x917421df197097a1f90a2944227069ee660e7685736fee7b512008901b274ec4

Dr. S.P. AGGARWAL
Director, TLC
Principal, Ramanujan College

UGC-STRIDE/RC2/546



UNIVERSITY GRANTS COMMISSION, NEW DELHI



SCHEME FOR TRANS-DISCIPLINARY RESEARCH
FOR INDIA'S DEVELOPING ECONOMY

UGC-STRIDE PROGRAM - COMPONENT - I

[File No. F.2-2/2019 (STRIDE-1) dt. 3/12/2019]

MIZORAM UNIVERSITY, Aizawl - 796004, Mizoram, India

This is to certify that **Mr. ISHTIYaq AHMAD SHEIKH**, Assistant Professor, Department of Biotechnology, Govt. Degree College Boys, Baramulla, affiliated to University of Kashmir, Hazratbal, Srinagar, Jammu and Kashmir, successfully completed the **UGC-STRIDE Refresher Course (Multidisciplinary)** on "*Research Methodology: Research Ethics, Methods, Skills, Writing and Communication*" held from 19 August, 2020 to 01 September, 2020 and obtained Grade **A**

Prof. Lalnundanga
Registrar

Prof. K.R.S. Sambasiva Rao
Vice Chancellor

Prof. G. Gurusubramanian
Coordinator

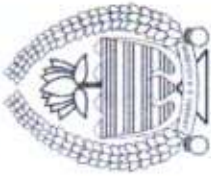

OFFICE OF THE

DEPUTY COMMISSIONER BARAMULLA

COMMENDATION CERTIFICATE



I, Dr. G. N. Itoo, Deputy Commissioner Baramulla confer this
commendation certificate in favour of

**Mr. Tanveer Ahmad Lone, Assistant Professor,
Govt. Degree College Baramulla**

*in recognition of his contribution for supporting District Administration
Baramulla as Incharge IT Cell, DC Office Baramulla, during
COVID-19 Pandemic Mitigation efforts.*

I wish him all the best for his future endeavors.

Dr. G. N. Itoo
Deputy Commissioner Baramulla.

No.: DCB/4808

Date: 12-09-2020



विद्यया ऽ मृतमश्नुते



UGC-Human Resource Development Centre University of Kashmir

NAAC Accredited Grade "A+"
Hazratbal, Srinagar

UGC –SPONSORED 84TH ORIENTATION PROGRAMME

This is to certify that Mr. Tanveer Ahmad Lone, Assistant Professor,
Department of Computer Applications, Govt. Degree College, Baramulla affiliated to
Jammu Kashmir University participated in the 84th Orientation Programme from February 20,
2020 to March 12, 2020 and obtained Grade (A+).

M. Ishaq Geer
In-charge Coordinator

Prof. Shabir Ahmad Bhat
Director HRDC

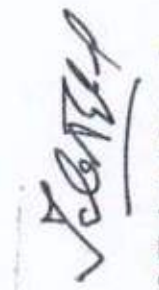
Prof. Talat Ahmad
Vice-Chancellor



**MAHATMA GANDHI
INSTITUTE OF TECHNOLOGY**

Kokilapet(Village), Gandlpet, Hyderabad, Telangana - 500075. www.mgit.ac.in



MOTIVATE
INNOVATE
EMPOWER

23
YEARS

INDIAN
SERVERS

MGIT-IT-FDP-1

DEPARTMENT OF INFORMATION TECHNOLOGY- MGIT
Certificate of Participation

This is to Certify that

TANVEER AHMAD LONE
of GDC BARAMULLA KASHMIR

has actively participated in One week Online "Faculty Development Program" on "CYBER ATTACKS & DIGITAL FORENSICS" Organized by Department of Information Technology, Mahatma Gandhi Institute of Technology in association with Indian Servers from "20th July,2020 to 24th July,2020".

Sai Satish

Mr.Sai Satish
CEO Indian Servers

Vijaya Lakshmi

Dr.D.Vijaya Lakshmi
Convener & HOD,IT

Prof. K. Jaya Sankar

Prof. K. Jaya Sankar
Principal, MGIT

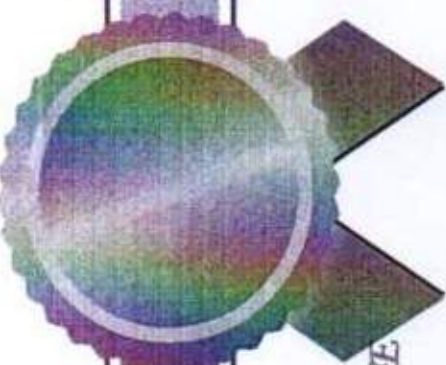

Presented to:

Mr. TANVEER AHMAD LONE

Assistant Professor,

GDC Boys Baramulla

Award for



**EXCELLENT PERFORMANCE IN
LOK SABHA ELECTION**

2019



Presented By

DISTRICT ELECTION OFFICER BARAMULLA

On

NATIONAL VOTER'S DAY - 25TH JAN, 2020



Office of the

**DISTRICT ELECTION OFFICER /
DEPUTY COMMISSIONER BARAMULLA**
COMMENDATION CERTIFICATE

I, Dr. G. N. Itoo, District Election / Deputy Commissioner, Baramulla,

hereby confer this commendation certificate in favour of

Mr. Tanveer Ahmad Lone, Assistant Professor, GDC Baramulla,

in recognition of his outstanding efforts as

I/C Polling/Counting Staff Randomization and Deployment,

during conduct of DDC Elections-2020.

I wish him all the best for his future endeavors.

This certificate may be recorded in the service record of the officer.

No.: DCB/PS/ 8860.

Date: 28-12-2020

Dr. G. N. Itoo
District Election Officer / Deputy Commissioner
Commissioner Baramulla

**UGC - HUMAN RESOURCE DEVELOPMENT CENTRE
DEVI AHILYA VISHWAVIDYALAYA, INDORE**



ज्ञान - विज्ञानं विमुक्तये

**REFRESHER COURSE IN COMPUTER APPLICATION
UGC-SPONSORED (IDC) 2020-2021**

CERTIFICATE OF PARTICIPATION

Government Degree College Baramulla
Assistant Professor, Government Degree College Baramulla
from 26th May, 2020 to 08th June, 2020

This is to certify that **Dr. Naseer Ahmad Lone**, Assistant Professor, Government Degree College Baramulla participated in Refresher Course in Computer Application (IDC)(Online Mode) from 26th May, 2020 to 08th June, 2020 and obtained grade (A).

Naseer Ahmad Lone

Director

Workshop on "NAAC TALK" under CPE/UGC TEP

GOVERNMENT DEGREE COLLEGE BARAMULLA

(NAAC Re-Accredited Grade 'A'
College with Potential for Excellence)
Telefax : 01952-234214
e-mail: varmulcollege@gmail.com
website: www.baramullacollege.net

No. GCB/UGC/ 4798-4857
Dated: 04-03-2020



Certificate of Participation

This is to certify that Prof./Dr./Mr./Ms. Reyaz Ahmad Wani (GDC (Boys) Baramulla)

participated in CPE/UGC sponsored One Day Workshop on "NAAC TALK" conducted as part of Teacher Enrichment Programme (TEP) of CPE/UGC Scheme organized by *Internal Quality Assurance Cell (IQAC)* of Government Degree College Baramulla held on 4th of March, 2020.

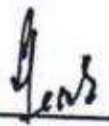
Abdul Majid Chalkoo
Coordinator IQAC
Convener UGC/CPE Scheme
Associate Professor Botany

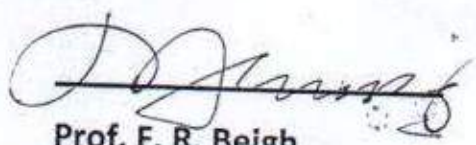
Prof. F. R. Beigh
Principal
Govt. Degree College Baramulla



सत्यमेव जयते

Ministry of Human Resource Development
Government of India



267

Faculty Development Centre
Mahatma Gandhi National Council of Rural Education
(Department of Higher Education, Ministry of Human Resource Development, Govt. of India)

Sponsored by
Pandit Madan Mohan Malaviya National Mission on Teachers and Teaching

Certificate

This is to certify that

Riyaz Ahmad Wani

of

Govt of J&K. Govt. DEGREE College Baramulla

Has Successfully Completed Five Days Online Faculty Development Program

on

'Mentoring and Facilitation Skills for Institutional Mentors'

May 27 - 31, 2020

Dr. W G Prasanna Kumar

Chairman

Mahatma Gandhi National Council of Rural Education
Ministry of Human Resource Development
Government of India



**J&K INSTITUTE OF MANAGEMENT PUBLIC ADMINISTRATION AND RURAL DEVELOPMENT,
REGIONAL CAMPUS: SIDHRA, JAMMU**

CERTIFICATE OF PARTICIPATION

This is to certify that:

Mr. Riyaz Ahmad Wani, Assistant Professor, Political Science
has successfully completed the Three Days Online Training Course

On

"Ethics and Values in Public Governance",
Sponsored by DOPT, Government of India
From 22nd to 24th December, 2020

Santosh Kaur

Course Coordinator

Gemal Khan

Director General



ఆంధ్ర విశ్వవిద్యాలయం

UGC-HUMAN RESOURCE DEVELOPMENT CENTRE UNIVERSITY OF HYDERABAD

Hyderabad - 500 046



CERTIFICATE OF PARTICIPATION

This is to certify that Dr. Saleem Farooq, Assistant Professor in Chemistry Department (Chemistry Research Lab, CRL), Govt. Degree College Baramulla (Higher Education Department J&K) has successfully completed two weeks online **Refresher Course on Chemistry** organized by the Human Resource Development Centre, University of Hyderabad from 8th to 20th February, 2021 and obtained grade **'B'**.

Ramu Sridhar

Dr. P. Ramu Sridhar
Course Coordinator

Y. Narasimhulu
Director

Certificate ID: HRDCRCC08

Grade 'A+'
85% and above

Grade 'A'
84% to 70%

Grade 'B'
69% to 60%

Grade 'C'
59% to 50%

Grade 'F'
less than 49%



Department of Mechanical Engineering
VISVESVARAYA NATIONAL INSTITUTE OF TECHNOLOGY
South Ambazari Road, Nagpur, MS, India - 440 010.

CERTIFICATE OF PARTICIPATION

THIS AWARD CERTIFIES THAT

DR. SALEEM FAROOQ

GOVT. DEGREE COLLEGE BARAMULLA, 193101 (HIGHER EDUCATION
DEPARTMENT) J&K

HAS SUCCESSFULLY PARTICIPATED IN

TEQIP-III Sponsored Interdisciplinary Online Faculty Development Program (O-FDP) on
"Teaching-Learning process for Beginners during COVID-19 Pandemic" held at
Department of Mechanical Engineering, V.N.I.T. Nagpur, MS, India.

Duration: Dates: 14 - 19 July, 2020 (Tue-Sun, 10:00 to 17:00 Hrs)



Nitin Kumar

Dr. Nitin Kumar Lantry
Coordinator & Speaker, VNIT Nagpur

Mohan V. Aware

Dr. Mohan V. Aware
TEQIP III Coordinator, VNIT Nagpur

Vilas R. Kalambar

Dr. Vilas R. Kalambar
Prof. & Head, Mechanical Engg., VNIT Nagpur

Reference No.: VNIT/MECH/O-FDP/saleemilam



AMAR SINGH COLLEGE

A Constituent College of Cluster University Srinagar

Gogji Bagh, Srinagar, J&K, 190008

NAAC Accredited



CERTIFICATE OF PARTICIPATION

This certificate is awarded to

DR. SALEEM FAROOQ

of

GOVT. DEGREE COLLEGE (BOYS) BARAMULLA

in recognition of active participation in the International Webinar on “Leveraging Artificial Intelligence in Healthcare- Special Reference to COVID-19 Pandemic” held on 28th July, 2020.

Certificate No: ASC/FMJZQI-CE002146

Dr. Syed Mutaahar Aaqib)
(CO-ORDINATOR)
Assistant Professor
Computer Sciences

(Prof. Syed Ishfaq Manzoor)
(CO-ORDINATOR)
Assistant Professor
Computer Sciences

(Dr. Anand Nayyar)
(RESOURCE PERSON)
Researcher & Scientist
Duy Tan University, Vietnam

(Prof. Bashir Ahmad Rather)
(PROGRAMME DIRECTOR)
Principal
Amar Singh College, Srinagar

(Prof. (Dr.) Yaseen Ahmad Shah)
(PATRON)
Director Colleges,
J&K, Higher Education Dept.



ISLAMIC UNIVERSITY OF SCIENCE AND TECHNOLOGY

Certificate of Participation

This is to certify that Dr. Saleem Farooq has participated in Online Workshop /Faculty-Development-Programme on Recent Research Trends in Information Technology from September 12, 2020 to September 18, 2020. The Programme was organised by Islamic University of Science and Technology (IUST), J&K in collaboration with Maulana Abul Kalam Azad University of Technology, West Bengal.

Dr. Assif Assad
HOD CSE, IUST

Prof. A. H. Moon
Dean SoET, IUST



विद्या ऽ विमुक्तये

UGC-Human Resource Development Centre University of Kashmir

NAAC Accredited Grade "A+"
Hazratbal, Srinagar

UGC – SPONSORED 84TH ORIENTATION PROGRAMME

This is to certify that Dr. Saleem Farooq, Assistant Professor, Department of Chemistry, Govt. Degree College, Baramulla affiliated to Kashmir University participated in the 84th Orientation Programme from February 20, 2020 to March 12, 20 and obtained Grade (A+).

M. Ishaq Geer
In-charge Coordinator

20-HRDC-36



Prof. Shabir Ahmad Bhat
Director HRDC



Prof. Talat Ahmad
Vice-Chancellor



UNIVERSITY GRANTS COMMISSION
HUMAN RESOURCE DEVELOPMENT CENTRE

مولانا آزاد نیشنل اردو یونیورسٹی

MAULANA AZAD NATIONAL URDU UNIVERSITY
(A Central University, accredited "A" Grade by NAAC)



UGC-Sponsored Online Multi-Disciplinary
"Refresher Course in Disaster Management"
(17th September to 30th September, 2020)

Regd. No. HRDC/MANUU/RC-DM/27

30th September 2020

This is to certify that, **Dr. Syed Masarat Geelani**, Assistant Professor in Urdu, Govt Degree College Boys Baramulla Jammu and Kashmir participated and successfully completed UGC sponsored online Multi-Disciplinary "**Refresher Course in Disaster Management**" organized by UGC - Human Resource Development Centre, Maulana Azad National Urdu University, Hyderabad from 17th September to 30th September, 2020 and obtained Grade "A".



Coordinator

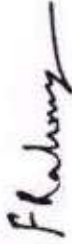

Director



Vice Chancellor

**UNIVERSITY GRANTS COMMISSION
HUMAN RESOURCE DEVELOPMENT CENTRE (HRDC)**



JAWAHARLAL NEHRU TECHNOLOGICAL UNIVERSITY HYDERABAD
(Established by Govt. Act No. 30 of 2008)
HYDERABAD, TELANGANA STATE (INDIA)

UGC-SPONSORED ORIENTATION PROGRAMME

CERTIFICATE

This is to certify that

..... Assistant Professor, Dept. of Urdu, Govt. Degree College, Baramulla, Jammu & Kashmir

affiliated to University of Kashmir University

participated in the Orientation Programme "57th ORIENTATION PROGRAMME"

from 20-01-2020 to 08-02-2020 and obtained Grade A

Dr. G.K. Viswanadh
Dr. G.K. Viswanadh
DIRECTOR

Dr. G.K. Viswanadh
Dr. G.K. Viswanadh
COORDINATOR

Dr. A. Govardhan
Dr. A. Govardhan
REGISTRAR

GOVERNMENT DEGREE COLLEGE BARAMULLA

(NAAC Re-Accredited Grade 'A'
College with Potential for Excellence)
Telefax : 01952-234214
e-mail: varmulcollege@gmail.com
website: www.baramullacollege.net

No. GCB/UGC/ 4798-4857
Dated: 4/3/2020

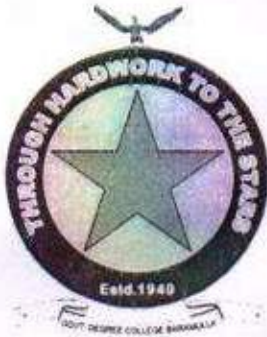

Certificate of Participation

This is to certify that Prof./Dr./Mr./Ms. Syed Masarat
Geelani (GDC (Boys) Baramulla)

participated in CPE/UGC sponsored One Day Workshop on "NAAC TALK"
conducted as part of Teacher Enrichment Programme (TEP) of CPE/UGC
Scheme organized by *Internal Quality Assurance Cell (IQAC)* of
Government Degree College Baramulla held on 4th of March, 2020.

COORDINATOR IQAC
Govt. College Baramulla
Coordinator IQAC
Convener UGC/CPE Scheme
Associate Professor Botany

Principal
Govt. Degree College Baramulla

Workshop on "NAAC TALK" under CPE/UGC TEP



UGC-Human Resource Development Centre
University of Kashmir

NAAC Accredited Grade "A"
 Hazratbal, Srinagar

UGC--SPONSORED 84TH ORIENTATION PROGRAMME

This is to certify that Dr. Rayees Ahmad Dar, Assistant Professor, Department of Statistics, Govt. Degree College for Boys, Baramulla affiliated to Kashmir University participated in the 84th Orientation Programme from February 20, 2020 to March 12, 2020 and obtained Grade (A+).

 Dr. M. Isbaq Geer
 Course Coordinator
 HRDC-02

 Prof. Shabir Ahmad Bhat
 Director HRDC

 Prof. Talat Ahmad
 Vice-Chancellor

Dated: 12-03-2020



Teaching Learning Centre, Ramanujan College
University of Delhi

under the aegis of

MINISTRY OF HUMAN RESOURCE DEVELOPMENT

PANDIT MADAN MOHAN MALAVIYA NATIONAL MISSION ON TEACHERS AND TEACHING

This is to certify that

Zubair Ahmad Thoker (Assistant Professor)

of

Government Boys Degree College Baramulla, Kashmir

successfully completed a 4-Week Induction/Orientation Programme for
"Faculty in Universities/Colleges/Institutes of Higher Education"
from September 01- September 30, 2020 and obtained a
grade **A+**



Blockchain.Hash: 0x121a67eb7883a4bc99a1992615a0303f5a94934dbc2d2de632294ab8c4604e3e

Dr. S.P. AGGARWAL
Director, TLC

Principal, Ramanujan College



Teaching Learning Centre, Ramanujan College
University of Delhi

under the aegis of

MINISTRY OF HUMAN RESOURCE DEVELOPMENT

PANDIT MADAN MOHAN MALAVIYA NATIONAL MISSION ON TEACHERS AND TEACHING

This is to certify that

Zubair Ahmad Thoker

of

Department of History Govt. Boys Degree College Baran

successfully completed a 2-Week Faculty Development Programme
"MANAGING ONLINE CLASSES AND CO-CREATING MOOCs 3
from July 25 - August 10, 2020 and obtained
grade **A**



Blockchain.Hash: 0xd7a554a71e697ab034cddb1f7627bc39c6d7063cbce31c21e23476b625702861

Dr. S.P. AGGARWAL
Director, TLC

Govt. Degree College Anantnag

NAAC Accredited Grade 'A' (CGPA, J.G.C)

College with potential for Excellence (CPE) status by UGC

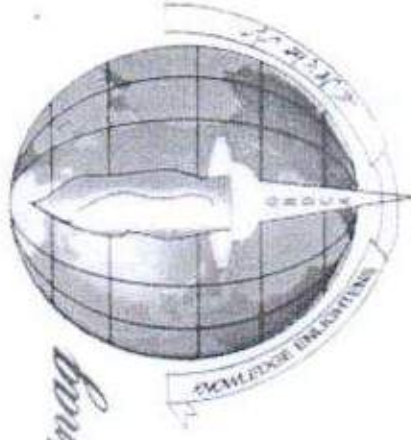

Certificate

OF PARTICIPATION

This is to certify that

ZUBAIR AHMAD THOKER

Participated in a one-day Webinar on "Pandemics in History and Lessons Learnt Thereof" organized by Department of History, Govt. Degree College Anantnag on 29th August, 2020

[Signature]



[Signature]

GOVERNMENT DEGREE COLLEGE BARAMULLA

(NAAC Re-Accredited Grade 'A'
College with Potential for Excellence)
Telefax : 01952-234214
e-mail: varmulcollege@gmail.com
website: www.baramullacollege.net

No. GCB/UGC/ 4798-4857
Dated: 4/3/2020

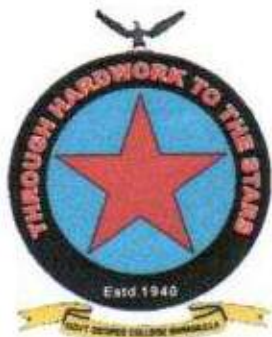

Certificate of Participation

This is to certify that Prof./ Dr./ Mr./ Ms. Amira Wali
GIDC (Boys) Baramulla

participated in CPE/UGC sponsored One Day Workshop on "NAAC TALK"
conducted as part of Teacher Enrichment Programme (TEP) of CPE/UGC
Scheme organized by *Internal Quality Assurance Cell (IQAC)* of
Government Degree College Baramulla held on 4th of March, 2020.

COORDINATOR IQAC
Govt. College Baramulla
Coordinator IQAC
Convener UGC/CPE Scheme
Associate Professor Botany

Principal
Govt. College Baram.
Principal
Govt. Degree College Baramulla

Workshop on "NAAC TALK" under CPE/UGC TEP



UNIVERSITY GRANTS COMMISSION
HUMAN RESOURCE DEVELOPMENT CENTRE (HRDC)
JAWAHARLAL NEHRU UNIVERSITY



UGC-SPONSORED SHORT-TERM COURSE (ONLINE)

This is to certify that

Ms. Amira Wali, Assistant Professor

Govt. Degree College Baramulla, University of Kashmir, Jammu & Kashmir

has Successfully completed the Short Term Course in Gender Sensitization & Social Justice held from 21st September, 2020 to 26th September, 2020

Bhaswati Das

Dr. Bhaswati Das
Course Coordinator

Prof. Brajesh Kumar Pandey
Director

Prof. M. Jagadeesh Kumar
Vice Chancellor



Teaching Learning Centre, Ramanujan College
University of Delhi

under the aegis of
MINISTRY OF HUMAN RESOURCE DEVELOPMENT
PANDIT MADAN MOHAN MALAVIYA NATIONAL MISSION ON TEACHERS AND TEACHING



Government Degree College Baramulla

This is to certify that
Dr. Baljeet Singh
of

successfully completed a 4-Week Induction/Orientation Programme for
"Faculty in Universities/Colleges/Institutes of Higher Education"
from September 01- September 30, 2020 and obtained a
grade A+



<https://doi.org/10.2801/india.102801.india.102801>

S. P. Aggarwal

Dr. S.P. AGGARWAL
Director, TLC
Principal, Ramanujan College



Wathar

Dr. K.I.
Programme Director
Ramanujan College



Teaching Learning Centre, Ramanujan College
University of Delhi



under the aegis of
MINISTRY OF HUMAN RESOURCE DEVELOPMENT
PANDIT MADAN MOHAN MALAVIYA NATIONAL MISSION ON TEACHERS AND TEACHING

This is to certify that

Dr. Baljeet Singh

of

Department of Anthropology, Government Degree College Baramulla

successfully completed a 2-Week Faculty Development Programme on
"MANAGING ONLINE CLASSES AND CO-CREATING MOOCs 3.0"
from July 25 - August 10, 2020 and obtained

grade **A+**



[Blockchain.Dish-12bb658da519e5630b5783d88542752d0f2bac389a325e21d33c27ae340](https://blockchain.dish-12bb658da519e5630b5783d88542752d0f2bac389a325e21d33c27ae340)

S.P. Aggarwal

Dr. S.P. AGGARWAL
Director, TLC
Principal, Ramanujan College



Mr. Sahil P

Mr. Sahil P
Co
Ramanujan C



J&K INSTITUTE OF MANAGEMENT PUBLIC ADMINISTRATION

&

RURAL DEVELOPMENT

Main Campus, M. A. Road, Srinagar/Regional Centre, Sidhra, Jammu

Mr. Rakhmat Shah, Associate Professor

This is to certify that _____ has successfully completed the Course / Seminar / Workshop on

“Role of National Service Scheme in Disaster Management”

conducted by the Institute from 22-04-2019 to 24-04-2019.

Self Attested

[Signature]
Course Coordinator

[Signature]
HOD Zoology
(Please Underline)
Baramulla
GCHE

[Signature]
Vice Chairman &
Director General



UGC HUMAN RESOURCE DEVELOPMENT CENTRE UNIVERSITY OF JAMMU

UGC SPONSORED GENERAL ORIENTATION COURSE
(UNDER RUSA)

This is to certify that

(Name of Participant) Mr. Riyaz Ahmad Wani Asstt. Prof. in Political Science
(College/University) Loyts Degree College, Baramulla (Designation)
Baramulla (Place)
Participated in the General Orientation Course
From 03-12-2019 to 12-12-2019 and obtained grade 'A'

DIRECTOR



VICE-CHANCELLOR



SKIMS MEDICAL COLLEGE, BEMINA, SRINAGAR



This is to certify that Nuzhat Rehman, NSS PROGRAMME OFFICER, GOVT DEGREE COLLEGE, BARAMULLA.

has participated in the Debate/Deliberations/Rally on the eve of
“International Day Against Drug Abuse & Illicit Trafficking 2019”

held on 26th June 2019 at SKIMS Bemina

organized by NSS Unit, SKIMS Medical College, Bemina

in collaboration with NSS Unit, University of Kashmir.

Prof. Shamim Ahmad Shah
Coordinator NSS
University of Kashmir

Prof. Reyaz Ahmad Untoo
Principal
SKIMS Medical College

Prof. Omar Javed Shah
Director SKIMS &
Ex-Officio Secretary

International Conference on Recent Advances in Interdisciplinary Sciences January 11-12, 2019

Certificate

This certificate is awarded to NUZHAT REHMAN from GDC Baramulla
for delivering an Invited Lecture/as Session Chair/Participation/Presentation of Research Paper
Titled Spectral analysis of newly metal ions
in the International Conference on "Recent Advances in Interdisciplinary Sciences" organized by the
Department of Electronics, University of Jammu in collaboration with IEEE EDS Delhi Chapter and IETE
Jammu Centre.

Dr. Rocky Gupta
Org. Secretary

Prof. Rakesh Vaid
Convener/HOD Electronics



Office of the

**DISTRICT DEVELOPMENT COMMISSIONER
BARAMULLA**



CERTIFICATE OF COMMENTATION

I, Dr. G. N. Itoo, District Development Commissioner Baramulla, hereby confer this appreciation certificate in favour of Mr. Tanveer Ahmad Lone, Assistant Professor of Govt. Degree College Baramulla in recognition of his extraordinary and exceptional effort during the conduct of Panchayat Election - 2018 and Lok-Sabha Election - 2019. His expertise in managing Employee Database (JK-EDIS) for Manpower Management, Training and Deployment of Poll Staff and handling various IT Applications during Elections and counting process, has been exemplary.

This certificate may be recorded in the service book of the employee.

I wish him all the best for his future endeavors.

18/4/20

Dr. G. N. Itoo

District Election Officer/ Deputy Commissioner
Baramulla

No./DEOB/2020/9653

Date: 18-04-2020



2021

Government of J&K
J&K Institute of Management, Public Administration &
Rural Development (IMPARD), Main Campus, Srinagar

Government of India
Office of the Registrar General &
Census Commissioner, India

This is to certify that Mr./Ms./Dr. Tanveer Ahmad Lone, (Designation) Assistant Professor, District Baramulla has successfully completed the Training Programme on "Training of Master Trainers for the Census of India - 2021 - Phase I" organized by the Office of the Registrar General and Census Commissioner, India, MHA and conducted by the J&K Institute of Management, Public Administration & Rural Development, Main Campus, Srinagar from 09/12/2019 to 14/12/2019.

Date : 14/12/2019

Place : JK IMPARD, Srinagar

Course Coordinator

Director General, JKIMPARD

UNIVERSITY GRANTS COMMISSION
HUMAN RESOURCE DEVELOPMENT CENTRE (HRDC)

SANT GADGE BABA AMRAVATI UNIVERSITY, AMRAVATI.

UGC - SPONSORED ORIENTATION PROGRAMME

This is to certify that

Assistant Professor

Dr. Naseer Ahmad Lone

(Designation)

(Name of the Participant)

Government Degree College, Baramulla. (Jammu & Kashmir).

(Place)

(College / University)

University

affiliated to : University of Kashmir. (Jammu & Kashmir)

Orientation Programme

Participated in the 47th

and obtained grade A

From : 18/11/2019 to 07/12/2019

Ph...

21 Days National Training Course (NTC-2019)

Livelihood Security through Sustainable Agriculture, Livestock Husbandry, and Allied Enterprises (25 February - 17 March 2019)

In Collaboration With



Govt. Degree College
Baramulla, J & K.



Department of Sheep Husbandry, Kashmir
Govt. of J&K



Department of Agriculture Kashmir
Govt. of J&K



AEDS
Agro-Environmental Developmental
Society (AEDS), Uttar Pradesh.

Certificate

Certified that Dr. Naseet Ahmad

Asst. Professor Computer Applications GDC Baramulla

participated in 21 Days National Training Course (NTC-2019) on "Livelihood Security through Sustainable Agriculture, Livestock Husbandry, and Allied Enterprises" w.e.f. 25-02-2019 to 17-03-2019 at Govt. Degree College Baramulla, J & K, India.

Yadav Prakash

Dr. Ved Prakash Yadav
Assistant Professor, Rajasthan Agricultural
Research Institute, Jaipur, Rajasthan.
Course Coordinator

Parvaiz

Dr. Parvaiz Ahmed Reshi
Jr. Scientist cum SMS (Animal Science),
SKUAST-Kashmir.
Course Coordinator

Chalkoo

A.M. Chalkoo
Associate Professor, Botany
GDC, Baramulla
Course Coordinator

Fazal Rahim

Prof. Fazal Rahim
Principal, GDC, Baramulla

Government Degree College Baramulla



(NAAC Re-Accredited Grade 'A', College with Potential for Excellence - CPE Status)

CERTIFICATE OF APPRECIATION

This is to appreciate Ubaid Shareef Makdoomi, GDC Baramulla for helping conducting one day workshop on "Identification of Pure Saffron using Foldscope A Novel Instrument for Low Cost Microscopy" jointly organized by The Department of Biotechnology and Genome Engineering & Societal Biotechnology Lab SKUAST-K on 26th June 20

at GDC Baramulla.

Apil M...

Dr. Anjash M. Husaini
SKUAST-K

(21, Indo-US, OBT & NMOIS Projects)

Ubaid

Head
Department of Biotechnology

Principle

Govt. Degree College, Baramulla



National Agriculture Development Co-operative Ltd.
Established Under Self Reliant Co-operative Act, 1999 | Under Government Control (Ministry of Cooperatives)

21 Days National Training Course (NTC-2019)

On
Livelihood Security through Sustainable Agriculture, Livestock Husbandry, and Allied Enterprises
(25 February - 17 March 2019)

In Collaboration With



Govt. Degree College
Baramulla, J & K.



Department of Sheep Husbandry, Kashmir
Govt. of J&K



Department of Agriculture Kashmir
Govt. of J&K



Agro-Environmental Developmental
Society (AEEDS), Uttar Pradesh

Certified that Mrs. Ubaid Shariq Mukhdoomi

Asst. Professor

Biotechnology

G.D.C. Baramulla

participated in 21 Days National Training Course (NTC-2019) on "Livelihood Security through Sustainable Agriculture, Livestock Husbandry, and Allied Enterprises" w.e.f. 25-02-2019 to 17-03-2019 at Govt. Degree College Baramulla, J & K, India.



Dr. Ved Prakash Yadav
Assistant Professor, Rajasthan Agricultural
Research Institute, Jaipur, Rajasthan.

Course Coordinator



Dr. Parvaiz Ahmed Rishi
Jr. Scientist cum SMS (Animal Science),
SKUAST-Kashmir.

Course Coordinator



A.M. Chalkoo
Associate Professor, Botany
GDC, Baramulla

Course Coordinator



Prof. Fazal Rahim Beig
Principal, GDC, Baramulla

Course Director



विज्ञान के माध्यम से शिक्षा
DEPARTMENT OF
SCIENCE & TECHNOLOGY



DEPARTMENT OF BIOTECHNOLOGY
Ministry of Science & Technology



Certificate

This is to certify that **UBAID SHARIF MAKHDOOMI** from **GOVT DEGREE COLLEGE BARAMULLA** participated in Regional **Workshop on Research Based Pedagogical Tools** held in **Department of Biotechnology and Bioinformatics, Sri Pratap College (School of sciences) Cluster University, Srinagar, Kashmir** from **16th July to 18th July, 2019**. He/she attended all sessions and actively participated in activities of this workshop, which also included a poster presentation of the work done during the workshop.

The workshop was funded by the Department of Biotechnology (DBT), Govt. of India, Department of Science and Technology (DST) Govt. of India, and organized by Center of Excellence in Science and Mathematics Education at Indian Institute of Science Education and Research (IISER) Pune (supported by MHRD) and Department of Biotechnology and Bioinformatics, Sri Pratap College, (School of sciences) (Cluster University, Srinagar, Kashmir). It was conducted by a team of facilitators who were trained by experts from the Sheffield Hallam University, UK

Prof L. S. Shashidhara
FNA, FASC, FNASC,
Professor and Coordinator

Centre of Excellence in Science and Mathematics Education,
Indian Institute of Science Education and Research (IISER) Pune

Knowledge partners

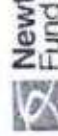



Ramanujan College
University of Delhi



Government of India
Ministry of Human Resource
Development

*Teaching Learning Centre
Ramanujan College
University of Delhi*

Under the Scheme
PANDIT MADAN MOHAN MALAVIYA
NATIONAL MISSION ON TEACHERS AND TEACHING
MINISTRY OF HUMAN RESOURCE DEVELOPMENT

Certificate

This is to certify that

Dr. Sheeraz Ahmad

of

*Department of Business Administration, Govt. Degree College,
Baramulla*

*participated in a 4-week
"Induction Training Programme"
conducted by the Teaching Learning Centre,
Ramanujan College, University of Delhi
from May 22 to June 21, 2019.*

DR. ALOK RANJAN PANDEY
Convenor
Induction Training Programme

DR. NIKHIL KUMAR RAJPUT
Convenor
Induction Training Programme

DR. S. P. AGGARWAL
(Principal)
Director, TLC



National Agricultural Development Co-operative Ltd.

Established Under Self Reliance Act, 1999

Under Government Control (Ministry of Cooperatives)

21 Days National Training Course (NTC-2019)

ON

Livelihood Security through Sustainable Agriculture, Livestock Husbandry, and Allied Enterprises
(25 February - 17 March 2019)

In Collaboration With



Govt Degree College
Baramulla, J & K



Department of Livestock Husbandry
Govt. Vet. Coll.



Department of Dairy Animal Husbandry
Govt. Vet. Coll.



National Agricultural Development Co-operative Ltd.
Ministry of Cooperatives

Certified that

Mr. Iftikhar Ahmad

Asst. Director Bichonology Govt. Vet. Coll. Baramulla

participated in 21 Days National Training Course (NTC-2019) on "Livelihood Security through Sustainable Agriculture, Livestock Husbandry, and Allied Enterprises" with 25-02-2019 to 17-03-2019 of Govt. Degree College Baramulla, J & K, India.

Dr. Ved Prakash Yadav

Senior Professor, Rajasthan Agricultural
Research Institute, Jaipur, Rajasthan,
Course Coordinator

Dr. Parviz Ahmad Rishi

Jr Scientist cum SMS (Animal Science),
SKUAST-Kashmir,
Course Coordinator

A.M. Chakrabarti

Associate Professor, Botany
GDC, Baramulla,
Course Coordinator

Prof. Faraz Rahim Beshir

Principal, GDC, Baramulla,
Course Director



GOVERNMENT COLLEGE OF EDUCATION

Institute of Advanced Studies in Education
CLUSTER UNIVERSITY, SRINAGAR

Maulana Azad Road Srinagar (J&K)

(NAAC RE-ACCREDITED GRADE "A" (CGPA 3.52)

Telephone No: - 2475368, Fax: 0194 2479807/ Email: icoe.ssr@gmail.com/ [http:// www.gcoetkmr.org](http://www.gcoetkmr.org)



CERTIFICATE

13th Induction Training Programme

This is to certify that Dr./Mr./Ms. Amie.a. Wali.....
Assistant Professor in the subject of Bio-Chemistry/ Chemistry/ Mathematics/
Kashmiri/ Social Work attended the "13th Induction Training Programme"
conducted by this institution from 25th Oct 2019 to 22nd Nov 2019 for 21 working days.

Sessions Delivered: Eighty Four (84)

Sessions Attended: 74

Grade Obtained A

Prof. Abdul Wahid Wali
Programme Coordinator

Dr. Seema Naz
Principal
IASE

Prof. (Dr) Yasmin Ashai
Nodal Officer/ Principal
GCW M.A Road



Certificate of Participation

This is to certify that Mr. Zubair Sayeed Masoodi of the department of Biotechnology has participated in a UGC/CPE sponsored seven day workshop on "Teacher Enrichment Program (TEP)" conducted between 13th of May 2023 & 19th of May 2023 as part of faculty development program of UGC held at Government Degree College Baramulla.

Zubair Sayeed Masoodi
Coordinator Workshop
Assistant Professor
Computer Applications

Abdul Majeed Chalkoo
Convener CPE Committee
Associate Professor
Botany

Prof. F. R. Beigh
Principal
Govt. Degree College
Baramulla

SRI PRATAP COLLEGE, SRINAGAR

ONE DAY SEMINAR ON

"LEARNING OUTCOMES BASED CURRICULUM FRAMEWORK (LDCF)

VIS-A-VIS BIOTECHNOLOGY

17th MAY 2020

Funded by :- Department of Higher Education, Govt. of Jammu & Kashmir

Certificate Of Participation

This is to certify that Prof. Usman Ahmad Sheikh Department of Biotechnology

from SRINAGAR participated in seminar on Learning Outcomes Based Curriculum Framework Vis-a-vis Biotechnology. The program was organized by Department of

Biotechnology & Bioinformatics.



Seminar Coordinators

(Dr. Roohi Mushtaq & Dr. Sadiq Majeed)



Seminar Director

Prof. (Dr.) Khursheed A. Khan



**SUPERCOMPUTING FACILITY FOR
BIOINFORMATICS & COMPUTATIONAL BIOLOGY
A CENTRE OF EXCELLENCE OF DBT, MST, GOVT. OF INDIA
INDIAN INSTITUTE OF TECHNOLOGY DELHI**



Certificate

This is to certify that

Prof. Rahmat Shah

has participated in the "Bioinformatics Workshop on Genomics, Proteomics, Drug Design & High Performance Computing" held under the aegis of Foundation for Innovation and Technology Transfer from 18th December, 2018 to 24th December, 2018 at the Supercomputing Facility for Bioinformatics & Computational Biology (SCFBio), Indian Institute of Technology Delhi.

(Signature)

**(Prof. B. Jayaram)
Coordinator
SCFBio, IIT Delhi**

(Signature)

**(Dr. A. Wall)
Managing Director
FITT, IIT Delhi**



Certificate of Participation

This is to certify that *Mr. Rakhmat Shah* of the department of Zoology has participated in a UGC/CPE sponsored seven day workshop on "Teacher Enrichment Program (TEP)" conducted between *18th of May 2018 & 16th of October 2018** as part of faculty development program of UGC held at Government Degree College Baramulla.

Zubair Sayeed Masoodi
Coordinator Workshop
Assistant Professor
Computer Applications

Abdul Majeed Chalkoo
Convenor CPE Committee
Associate Professor
Botany

Prof. F. R. Beigh
Principal
Govt. Degree College,
Baramulla

* The workshop was conducted as a series of 14 sessions of 3 hours duration each between the date of commencement and date of completion as mentioned, aggregating to a total of 42 hours.

Certificate

This is to certify that Mr Ajmair Singh Sodhi, Assistant Professor, Department of Industrial Fish & Fisheries, Govt. Degree College, Kathua attended a three week Special Summer School Refresher Course in Sciences from August 09, 2018 to September 07, 2018 and obtained Grade (A)

Mujazif

Prof Khalid Majid Fazili
Course Coordinator
KU2018-HRDC-20

Wani

Prof. Gull Mohammad Wani
Director HRDC

Talat Ahmad

Prof. Talat Ahmad
Vice-Chancellor

Dated: 18-09-2018



OFFICE OF THE CHAIRMAN
DISTRICT LEGAL SERVICES AUTHORITY
(PRINCIPAL DISTRICT AND SESSIONS JUDGE), BARAMULLA



CERTIFICATE OF PARTICIPATION

This certificate is awarded to **Prof./Dr./Mr./Ms. NUZHAT REHMAN, Head, Department of Chemistry, Government Degree College, Baramulla** in recognition of **his/her** participation in a '**Campaign for enhancing legal services to women inmates and their accompanying children in prisons for spelling out the objectives, strategies, activities, and expected outcomes**' as per the directions of National Legal Services Authority (NALSA), under the patronage of Honorable Supreme Court of India, from 12th to 17th May, 2018 at District Sub jail (women wing), Baramulla.

Chairman,

District Legal Services Authority
(Principal District & Sessions Judge), Baramulla

Chairman

District Legal Services Authority
Pr. District & Session Judge
Baramulla



Certificate of Participation

This is to certify that *Ms. Nuzhat Rehman* of the department of *Chemistry* has participated in a UGC/CPE sponsored seven day workshop on "**Teacher Enrichment Program (TEP)**" conducted between *18th of May 2018 & 16th of October 2018** as part of faculty development program of UGC held at Government Degree College Baramulla.

Zubair Sayeed Masoodi
Coordinator Workshop
Assistant Professor
Computer Applications

Abdul Majeed Chalkoo
Convenor CPE Committee
Associate Professor
Botany

Prof. F. R. Beigh
Principal
Govt. Degree College,
Baramulla

Teacher Enrichment Programme (TEP)

2 DAY WORKSHOP

ON

HANDS-ON TRAINING ON SCIENCE LABORATORY EQUIPMENT AND
INSTRUMENTATION FOR FACULTY AND RESEARCH SCHOLARS

28th to 29th November, 2018



Department of Chemistry, University of Kashmir, Srinagar

Certificate

This is to Certify that

Ms. Nuzhat Refiman, Assistant Professor, Govt. Degree College, Baramulla

attended all the sessions of the Two day Workshop organized by the Department in Collaboration
with M/S Equiptronics Mumbai.

A stylized signature in black ink, likely belonging to Prof. M. A. Khuroo.

Prof. M. A. Khuroo
Head, Department of Chemistry.

A stylized signature in black ink, likely belonging to Mr. Imdad Khambati.

Mr. Imdad Khambati
CEO Equiptronics



Sr. No. : 156

UGC HUMAN RESOURCE DEVELOPMENT CENTRE UNIVERSITY OF JAMMU

This is to certify that

Ms. Nuzhat Rehman Assistant Professor in Chemistry
(Name of Participant) (Designation)

Govt. Degree College, Boys, Baramulla
(College/University) (Place)

participated in the Three Weeks Refresher Course in Chemistry
from 03-12-2018 to 23-12-2018 and obtained grade 'A'.

Rauf Samir

COURSE COORDINATOR

[Signature]

DIRECTOR

[Signature]

VICE-CHANCELLOR

2 DAY WORKSHOP

ON

HANDS-ON TRAINING ON SCIENCE LABORATORY EQUIPMENT AND
INSTRUMENTATION FOR FACULTY AND RESEARCH SCHOLARS

28th to 29th November, 2018



Department of Chemistry, University of Kashmir, Srinagar

Certificate

This is to Certify that

Dr. Saleem Farooq, Assistant Professor, Govt. Degree College, Baramulla

attended all the sessions of the Two day Workshop organized by the Department in Collaboration
with M/S Equiptronics Mumbai.

Prof. M. A. Khuroo
Head, Department of Chemistry.

Mr. Imdad Khambhatt
CEO Equiptronics

2 DAY WORKSHOP

ON

HANDS-ON TRAINING ON SCIENCE LABORATORY EQUIPMENT AND
INSTRUMENTATION FOR FACULTY AND RESEARCH SCHOLARS

28th to 29th November, 2016



Department of Chemistry, University of Kashmir, Srinagar

Certificate

This is to Certify that

Ishtriyaq Ahmad Shikiki, Assistant Professor, Govt. Degree College, Boys, Baramulla

attended all the sessions of the Two day Workshop organized by the Department in Collaboration
with M/S Equiptronics Mumbai.

Prof. M. A. Khuroo
Head, Department of Chemistry

Mr. Indrajit Khambhat
CEO Equiptronics

National Highway, Khawaja Bagh
Baramulla, J&k - 193101



Certificate of Participation

This is to certify that *Dr. Saleem Farooq* of the department of *Chemistry* has participated in a UGC/CPE sponsored seven day workshop on "Teacher Enrichment Program (TEP)" conducted between *18th of May 2018 & 16th of October 2018** as part of faculty development program of UGC held at Government Degree College Baramulla.

Zubair Sayeed Masoodi
Coordinator Workshop
Assistant Professor
Computer Applications

Abdul Majeed Chalkoo
Convenor CPE Committee
Associate Professor
Botany

Prof. F. R. Beigh
Principal
Govt. Degree College,
Baramulla

* The workshop was conducted as a series of 14 sessions of 3 hours duration each between the date of commencement and date of completion as mentioned, aggregating to a total of 42 hours.

Government Degree College Baramulla



(NAAC Re-Accredited Grade 'A', College with Potential for Excellence – CPE Status)

CERTIFICATE OF PARTICIPATION

This is to certify that Prof. Syed Rehmat Shah of Govt. Degree College Baramulla attended one day UGC/CPE sponsored workshop on 'Sustainance of CPE – Status' organized by Govt. Degree College Baramulla on 21st October, 2017 in the Conference Hall.

(Dr. Nisar Ahmad Khan)
Joint Secretary UGC/CPE

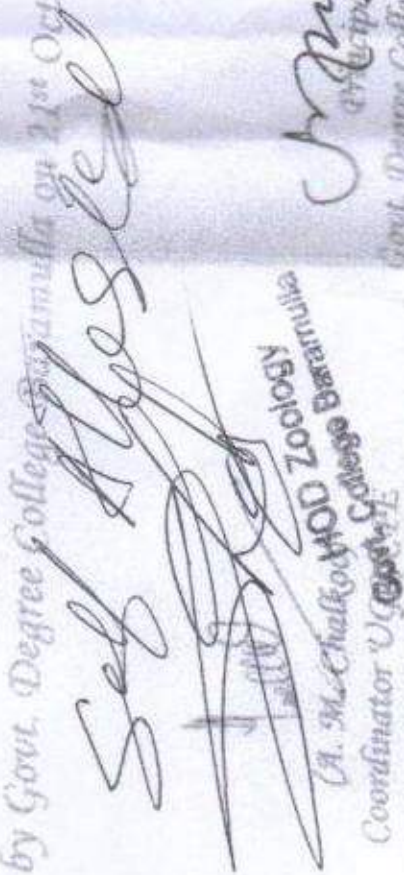
(A. M. Chalko) HOD Zoology
Coordinator UGC/CPE
Govt. Degree College Baramulla



विज्ञान एवं प्रौद्योगिकी विभाग
DEPARTMENT OF
SCIENCE & TECHNOLOGY



MHRD

Ministry of Human Resource Development
Ministry for Teachers and Training



Bio techno
School of Biotechnology
University of Kashmir

Certificate

This is to certify that **RAKHMAT SHAH** from **GDC BARAMULLA** participated

Regional Workshop on Research Based Pedagogical Tools held from **3rd July to 5th July, 2017** at University of Kashmir, Srinagar, J&K. He/she attended sessions and actively participated in all activities of this workshop, which also included a poster presentation of the work done during the workshop. The workshop was funded by the Department of Science & Technology (DST), Govt. of India and organized by Center of Excellence in Science Mathematics Education at Indian Institute of Science Education and Research (IISER)Pune (supported by MHRD, Govt. of India) and University of Kashmir, Srinagar, J&K. It was conducted by a team of facilitators who were trained by experts from the Sheffield Hallam University.

Co-ordinator, on behalf of all organizers

Sudh K. Bhatia
HOD ZOOLOGY
Govt. College Baramulla

Prof L. S. Shashidhara
FNA, FASC, FNASC,
Professor and Coordinator

Centre of Excellence in Science and Mathematics Education,
Indian Institute of Science Education and Research (IISER) Pune

Frontiers in Chemical Science (FICS) - 2017

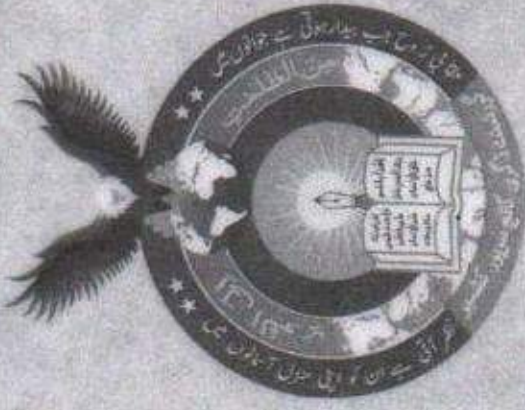

a national Symposium

Nov. 04-05, 2017

Department of Chemistry,

Govt. Degree College Sopore, 193201, J&K India

Certificate

This is to certify that Prof. / Dr / Mr / Mrs. Nuzhat Rehman of G.D.C.

Banambur has participated in the FICS-2017 and Chaired a session

Delivered an Invited Talk/ Presented an oral paper/ Posted

entitled Gold chloride (AuCl₃) --- Reaction yield,

Chief Patron

Organizing Secretary

Convener

SCIENCE ACADEMIES LECTURE WORKSHOP-2017

ON

Modern Trends in Chemistry & Chemistry Education

July 19-20, 2017, University of Kashmir, Srinagar

ON BEHALF OF THE SCIENTIFIC COMMITTEE

CERTIFICATE OF PARTICIPATION

This is to certify that Mr./Miss./Dr. Nuzhat Rehman Faculty /Scholar/
Student at G.D.C. Boys Baramulla participated in the two day's
Science Academies Lecture Workshop held at Ibn-e-Khaldoon Auditorium, University of
Kashmir, Srinagar.

(Prof. G. M. Peerzada)
Coordinator-Workshop

Uday Maitra

(Prof. Uday Maitra)
Convener-Workshop



Certificate

participated in

NUZHAT REHMAN from **BDC BARAMULLA**

Regional Workshop on Research Based Pedagogical Tools held from 3rd July to 5th July, 2017 at University of Kashmir, Srinagar, J&K. He/she attended all sessions and actively participated in all activities of this workshop, which also included a poster presentation of the work done during the workshop. The workshop was funded by the Department of Science & Technology (DST), Govt. of India and organized by Center of Excellence in Science and Mathematics Education at Indian Institute of Science Education and Research (IISER)Pune (supported by MHRD, Govt. of India) and University of Kashmir, Srinagar, J&K. It was conducted by a team of facilitators who were trained by experts from the Sheffield Hallam University.

Co-ordinator, on behalf of all organisers

Shakti

Prof L. S. Shashidhara
FNA, FASc, FNASC,
Professor and Coordinator

Centre of Excellence in Science and Mathematics Education,
Indian Institute of Science Education and Research (IISER) Pune

Government Degree College Baramulla



(NAAC Re-Accredited Grade 'A', College with Potential for Excellence – CPE Status)

CERTIFICATE OF PARTICIPATION

This is to certify that Prof. Nuzhat Rehman of Govt. Degree College Baramulla attended one day UGC/CPE sponsored workshop on "Sustainance of CPE - Status" organized by Govt. Degree College Baramulla on 21st October, 2017 in the Conference Hall.

(Dr. Nisar Ahmad Khan)
Joint Secretary UGC/CPE

(A. M. Chalkoo)
Coordinator UGC/CPE

Principal
Govt. Degree College Baramulla



Indian Red Cross Society

Jammu & Kashmir State Branch



Certificate of Participation

This is to certify that Mr./Ms. Nuzhat Rehman, NSS Officer
R/o Sangri Baramulla participated in the

3 Days Training of Volunteers under
Social & Emergency Response Volunteer (SERV) Programme
organised by Indian Red Cross Society, J&K State Branch
held at Govt. Boys Degree college Baramulla

From 13th Nov 2017

To 15th Nov 2017

(M. S. Rather) IAS Retd.
General Secretary
IRCS-J&K State Branch

Government Degree College Baramulla



(NAAC Re-Accredited Grade 'A', College with Potential for Excellence – CPE Status)

CERTIFICATE OF PARTICIPATION

This is to certify that Dr. Saleem Farooq of Govt. Degree College Baramulla attended one day UGC/CPE sponsored workshop on "Sustainance of CPE - Status" organized by Govt. Degree College Baramulla on 21st October, 2017 in the Conference Hall.

(Dr. Nisar Ahmad Khan)
Joint Secretary UGC/CPE

(A. M. Chalkoo)
Coordinator UGC/CPE

Principal
Govt. Degree College Baramulla



Institute of Advanced Studies in Education Government College of Education, M. A. Road, Srinagar

UGC RE-ACCREDITED Grade 'A' (CGPA 3.52)

Phone / Fax: 0194 2479807 Email: gcoe.sgr@gmail.com

Certificate of Participation

This is to certify that

Dr. / Mr. / Ms. ✓ *Syed Masrat Geelani*

Deputed from Amar Singh College, Srinagar (Kashmir)

Attended

6th Induction Training Programme

**for Newly Recruited Assistant Professors of Urdu & Education,
Department of Higher Education, Govt. of J&K (Kashmir Division)**

w. e. f. 22nd March, 2017 (for one week)

Organized by this Institution



Prof. (Dr.) *[Signature]*
Principal

Prof. *[Signature]*
Principal



Certificate of Participation

This is to certify that *Ms. Syed Masrat Geelani* of the department of *Urdu* has participated in a UGC/CPE sponsored seven day workshop on "**Teacher Enrichment Program (TEP)**" conducted between *18th of May 2018 & 16th of October 2018** as part of faculty development program of UGC held at Government Degree College Baramulla.

Zubair Sayeed Masoodi
Coordinator Workshop
Assistant Professor
Computer Applications

Abdul Majeed Chalkoo
Convenor CPE Committee
Associate Professor
Botany

Prof. F. R. Beigh
Principal
Govt. Degree College,
Baramulla



SRI PRATAP COLLEGE, SRINAGAR

(NAAC Re-Accredited GRADE "A")

DEPARTMENT OF BIOTECHNOLOGY & BIOINFORMATICS



Organised

Two Day National Seminar-cum-Workshop on "SKILL DEVELOPMENT IN BIOTECHNOLOGY"
(20-21 November, 2017)

Funded By
Cluster University, Srinagar (CUS)

CERTIFICATE OF PARTICIPATION

This is to certify that Dr./Prof./Mr./Mrs./Ms. UBAID SHARIE MAKHDOOMI Department of
BIOTECHNOLOGY of Institute/College/University G.D.C., BARAMULLAH.

attended the seminar-cum-workshop as Delegate/Resource person/Member Organizing
Committee/Rapporteur/Organizing Secretary.

ORGANISING SECRETARIES

Dr. Roohi Mushtaq & Dr. Sadiq Majeed

PRINCIPAL/ SEMINAR DIRECTOR

Prof. (Dr.) Parveen Pandit

VICE-CHANCELLOR

Prof. (Dr.) Sheikh Javid Ahmad

SRINAGAR,
the 21st November, 2017



INDIRA GANDHI NATIONAL OPEN UNIVERSITY
REGIONAL CENTRE, KARNAL

CERTIFICATE OF PARTICIPATION

This is to certify that Prof./Dr./Mr./Ms. Navshad Ahmad Wani

of Govt. Degree College, Baramulla, J&K

participated in two days' Orientation Programme for Academic Counsellors of MA Psychology held at IGNOU Regional Centre, Karnal during 09th-10th September, 2016.

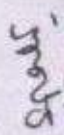
(Dr. Swati Patra)
Programme Coordinator
MAPC, SOSS, IGNOU, New Delhi

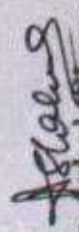
(Dr. Ashok Sharma)
Regional Director
IGNOU RC, Karnal



UGC

**UGC HUMAN RESOURCE DEVELOPMENT CENTRE (HRDC)
UNIVERSITY OF JAMMU**

This is certify that Mr. Navshad Ahmad Wani, Assistant Professor
Govt. Degree College, Baramulla participated in the Three Weeks Refresh
Course in Human Rights (I.D.) from 6th December 2016 to 27th December 2016
and awarded Grade "A"

Ref. No: HRDC-C/JU/16/135

DIRECTOR



COURSE CO-ORDINATOR



VICE-CHANCELLOR



म - विज्ञानं विमुक्तये

UGC-Human Resource Development Centre University of Kashmir

NAAC Accredited Grade "A"

Hazratbal, Srinagar

Certificate

This is to certify that Ms. Syed Masarat Geelani, Ph.D Research Scholar
Department of Urdu, University of Kashmir, Srinagar attended One Week Workshop
on Research Methodology for Humanities Scholars/College & University Teachers
organised by UGC-Human Resource Development Centre, University of Kashmir, Srinagar
from 01st September, 2015 to 08th September, 2015.

Dr. Aejaz Mohammed Sheikh
Course Coordinator

Prof. Mohi-ud-Din Sangmi
Director HRDC





Government of India
Ministry of Human Resource
Development

*Teaching Learning Centre
Ramamujan College
University of Delhi*

Sponsored by

MINISTRY OF HUMAN RESOURCE DEVELOPMENT
PANDIT MADAN MOHAN MALAVIYA
NATIONAL MISSION ON TEACHERS AND TEACHING

Certificate

This is to certify that

Arshad Ahmad Yattoo

of

P. G. Department of Computer Sciences, Govt. Degree
College Baramulla

successfully completed Two Weeks Faculty Development Programme on
"ADVANCED CONCEPTS FOR DEVELOPING MOOCS"
from July 02 - July 17, 2020.



Dr. S.P. AGGARWAL
(Principal)

Dr. Ashish Kumar Shukla
(Convenor)



Government of India
Ministry of Human Resource
Development

*Teaching Learning Centre
Ramanujan College
University of Delhi*

Sponsored by
MINISTRY OF HUMAN RESOURCE DEVELOPMENT
PANDIT MADAN MOHAN MALAVIYA
NATIONAL MISSION ON TEACHERS AND TEACHING

Certificate

This is to certify that

Mr. Arshad Ahmad Yattoo

of

Govt. Degree College, Baramulla

has successfully completed One Week Faculty Development Programme on
"Open Source Tools for Research" from June 08 - June 14, 2020.



Dr. S.P. AGGARWAL
(Principal)

Mr. Sahil Pathak
(Convenor)

Association with

IFERP[®]

g engineers... developing research

CERTIFICATE OF PARTICIPATION

Organized



1ST INTERNATIONAL CONFERENCE ON MULTIDISCIPLINARY AND CURRENT EDUCATIONAL RESEARCH (ICMCER-2020)

30TH - 31ST JULY 2020 | VIRTUAL CONFERENCE

Arshad Ahmad Yatoo

This is to certify that
Lovely Professional University presented his/he

research paper titled *"Automated plant disease detection and diagnosis using Deep Learning. A Review"*

.....in the
"1st International Conference on Multidisciplinary and Current Educational Research (Virtual Conference)" organized by
Mahachulalongkornrajavidyalaya University, Ayutthaya, Thailand held on 30th - 31st July 2020.



Prap

Dr. Phraratsutaporn
Associative Professor & Dean
Faculty of Education
Mahachulalongkornrajavidyalaya University
Thailand

L Klomkul

Dr. Lampong Klomkul
Acting Director for Research, Information
and Academic Services, ASEAN Studies Centre
Mahachulalongkornrajavidyalaya University
Thailand



Rudra

Mr. Rudra Bhanu Satpathy
CEO & Founder
IFERP

Certificate No: _____

Dated: _____

Government Degree College Baramulla, J&



Re-Accredited by NAAC with Grade "A"
College with Potential for Excellence (CPE)

Certificate of Participation

This is to certify that **PROF. ARSHAD AHMAD YATOO** working as **ASSISTANT PROFESSOR** in the Department of **COMPUTER APPLICATION** actively participated as **RESOURCE PERSON** in

One Week Capacity Building Workshop

Organized by IQAC and Psychological cum Career Counseling and Placement Cell

w. e. f. **08-02-2021** to **13-02-2021** at Department of Computer Science

Coordinator
IQAC

Coordinator
PCC & PC

Principal
Govt. Degree College Baramulla



Central Library

GOVERNMENT DEGREE COLLEGE TANGMARG

PARTICIPANT ID: ARSHADYATOO@GMAIL.COM
CERTIFICATE ID: GDC-TMG-RD24-44

Higher Education Department, Jammu and Kashmir



Spoken Tutorial Project

Powered by

Ministry of Human Resource Development

Govt. of India

Certificate of Participation

This Certificate is awarded to

MR. ARSHAD AHMAD YATOO

for successful participation & completion of **National Level One Week Online Faculty Development Program**
MOODLE: Learning Management System organized by Central Library, Govt. Degree College, Tangmarg
in association with Spoken Tutorial Project, IIT Bombay from 20th June to 24th June 2020.

Prof. (Dr.) Yasmeen Farooq

Patron

Principal, Govt. Degree College, Tangmarg

Dr. Rumman Gul

FDP Coordinator

Librarian, Govt. Degree College, Tangmarg

Ms. Hajra Bano

Training Coordinator (J&K)

Spoken Tutorial project IIT Bombay

LOYOLA COLLEGE

Vettavalam, Tiruvannamalai Dist, Tamilnadu - 606754



Certificate of Participation

This is to certify that *Dr / Ms / Mr*..... **Arshad Ahmad Yatoo**
participated in the Webinar on “ **Machine Learning: Linear Regression** ”
jointly organized by the Departments of Computer Applications and
Computer Science of Loyola College, Vettavalam on **17.06.2020**.

Albert William

Rev. Dr. Albert William, S.J.
Secretary and Convener

Rev. Dr. V. Britto, S.J

Rev. Dr. V. Britto, S.J.
Principal

LOYOLA COLLEGE

Vettavalam, Tiruvannamalai Dist, Tamilnadu - 606754



Certificate of Participation

This is to certify that *Dr / Ms / Mr*..... **Arshad Ahmad Yatoo**
participated in the Webinar on *"Cloud Computing and Azure"*
jointly organized by the Departments of Computer Applications and
Computer Science of Loyola College, Vettavalam on **16.06.2020**.

Albert William

Rev. Dr. Albert William, S.J.
Secretary and Convener

Rev. Dr. V. Britto, S.J.

Rev. Dr. V. Britto, S.J.
Principal



विज्ञानं विमुक्तये



CCSD - Human Resource Development Centre University of Kashmir

NAAC Accredited Grade "A+"

Hazratbal, Srinagar

Certificate

This is to certify that Mr. Mudasir Ahmad, Assistant Professor, Department of

English, Govt. Degree College, Baramullah attended a three-week 83rd Genera

Orientation Course from July 09, 2019 to July 30, 2019 and obtained Grade (A).

Sessions Conducted: 72 (Seventy Two)

Sessions Attended: 72 (Seventy Two)

Dr. M. Ishaq Geer
Course Coordinator

Prof. Shabir Ahmad Bhat
Director HRDC

Prof. Talat Ahmad
Vice-Chancellor

KU2019-HRDC-13

Dated: 30-07-2019



Human Resource Development Centre
 University of Kashmir

NAAC Accredited Grade "A"
 Hazratbal, Srinagar

Certificate

This is to certify that Mr Arshed Irshad, Assistant Professor, Department English, Govt. Degree College Boys, Baramulla attended a four week 81st Gene Orientation Course from November 12, 2018 to December 13, 2018 and obtained

Grade (A)

Sessions Conducted: 96 (Ninety Six)

Sessions Attended: 86 (Eighty Six)

Dr. M. Ishaq Geer
 Course Coordinator

Prof. Gull Mohammad Wani
 Director HRDC

Prof. Talat Ahmad
 Vice-Chancellor

Dated: 13-12-